

ANTTRON

TM250

SD encoder
DVB-T out



USER MANUAL V1.0

Contents

1 - Safety considerations.....	3
2 - Description of the different elements.....	4
3 - Installation and menu structure.....	5
3.1 - Installation	5
3.2 - Powering up.....	5
3.3 - Menu structure.....	6
4 - Setting up the TM250	7
4.1 - The DVB settings menu	7
4.2 - The AV settings menu	8
4.2.1 - Video settings	8
4.2.2 - Audio settings	9
4.3 - The TS settings menu	9
4.4- The language menu	11
4.5 - Default configuration.....	11
5 - Programming using a PC	11
6 - Technical specifications	12

1 - Safety considerations

1.1 CONNECTING TO THE MAINS SUPPLY

This product has to be connected to the mains supply. If there is the slightest doubt concerning the type of connection available on the installation, please contact your supplier of electricity. Before carrying out maintenance operation or modification of the installation, the modulator has to be disconnected. Remark : only use the supplied power adaptor.

1.2 OVERVOLTAGE

An overvoltage on the mains supply, can cause shortcircuits or fire. Never overload the power lines.

1.3 LIQUIDS

This module should be protected from splashes. Please assure yourself that no containers containing liquids are placed on this module. Also be aware of other persons splashing liquids on the module.

1.4 CLEANING

Disconnect the module before cleaning. Use only a humid cloth without solvent.

-

1.5 VENTILATION

In order to assure an adequate air circulation and to prevent overheating, the ventilation holes should not be obstructed. The module may not be installed in a hermetically sealed environment. Other electronic products or heat producing items may not be placed upon or near the module.

1.6 ACCESSORIES

The use of accessories not manufactured by the manufacturer can cause damage to the module.

1.7 INSTALLATION OF THE MODULE

The module must be installed in a place well protected from direct sunlight. All measures have to be taken to avoid installation in humid or sunny place. Do not install near heating elements or other devices producing heat. Assure yourself that the module is placed at least 10 cm from other equipment with is susceptible to electromagnetic radiation. Do not install the module on instable items. A fall can cause physical or material damage.

2 - Description of the different elements

- C1** Power supply input (5V/2A)
- C2** USB input (for programming the TM250 by PC)
- C3** RF input
- C4** RF output



- C6** Video input
- C7** Audio left input
- C8** Audio right input

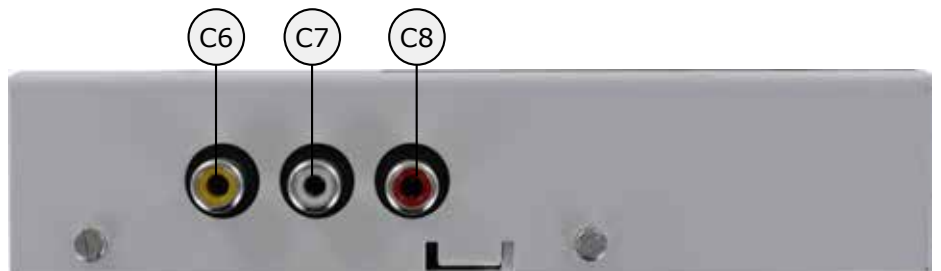

- A1** Display
- T1** **CANCEL/RETURN** button (⊗)
- T2** **ENTER** button (⬇)
- T3** ▶ (move forward/down) button
- T4** ◀ (move backward/up) button

3 - Installation and menu structure

3.1 - Installation

Install the TM250 against a wall using the wall fixation brackets to ensure cooling of the housing through natural convection. (see drawing)

Connect the audio and video source using a RCA cable. Connect the RF input cable (if present) and the RF output cable. If the RF input is not used, please connect a 75 ohm terminating resistor to it. Once the modulator installed and the cables connected, please proceed connecting the power supply to the modulator.

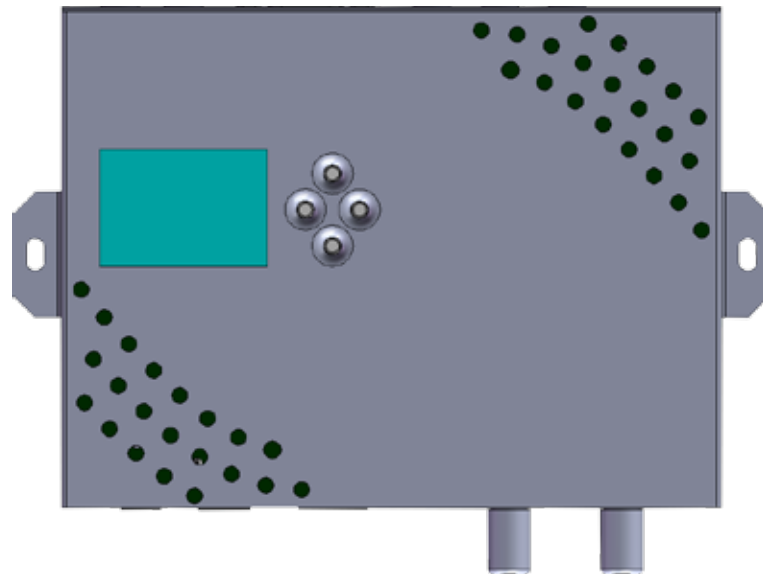

3.2 - Powering up

Plug in the connector of the power supply. The display will show the ANTTRON logo while booting. Once the modulator has booted correctly the main menu will appear.

In the first line the model number is displayed (TM250) followed by the installed firmware version.

When the modulator is encoding, the actual resolution is displayed in the bottom line of the display. When the modulator is initialising, the mention INIT is displayed at the bottom line.

```
TM250 1.0
DVB SETTINGS
A/V SETTINGS
TS SETTINGS
LANGUAGE
704x576-25fps
```

3.3 - Menu structure

The TM250 has different menus allowing easy access to the different parameters and to change them when necessary. Below you will find the structure of the different menus.

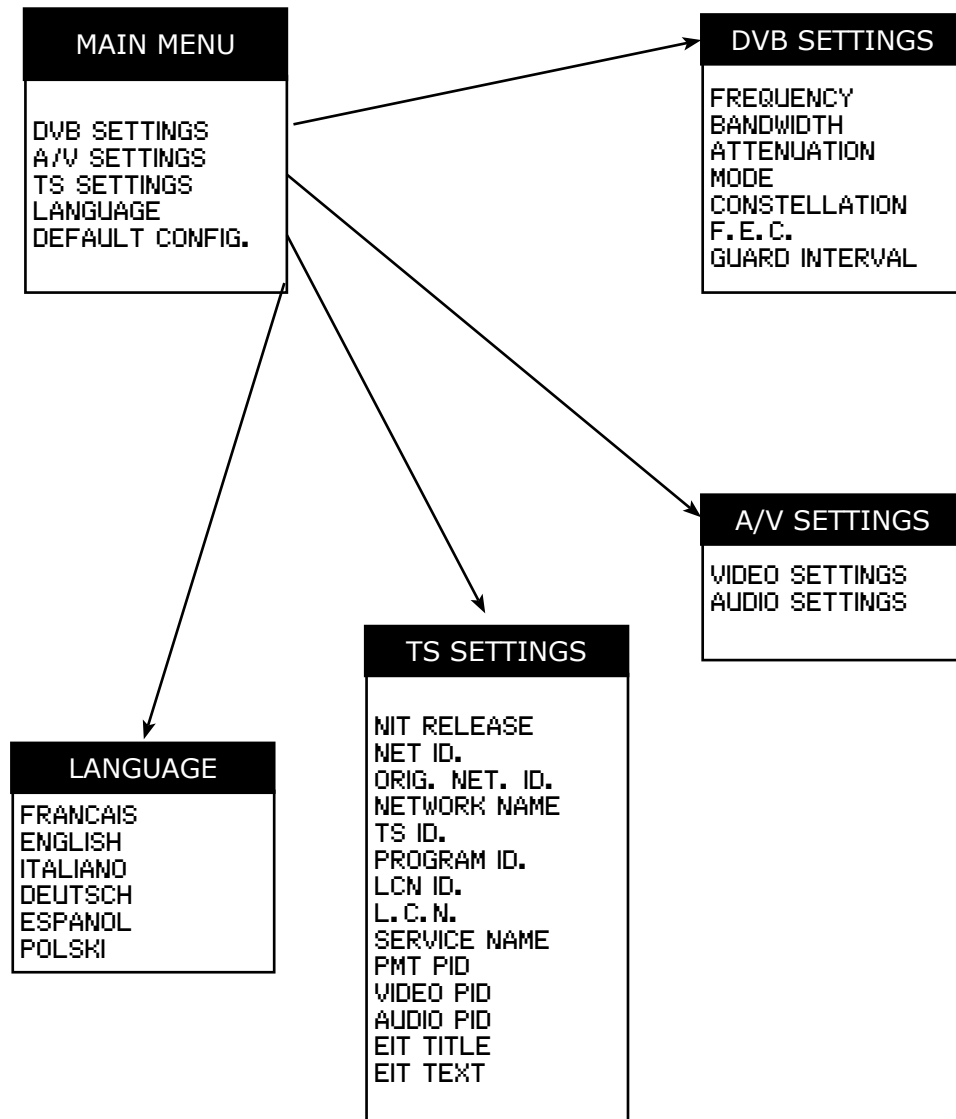

In order to go from one menu to the other use the MOVE **UP/DOWN** keys to select the menu option. Press the **ENTER** button to select this option. Press the **CANCEL** button to go back to the previous menu.

To set parameters, whether you have the option to select a specific value. In the other case some number or text string should be entered. In that case, use the buttons **▶** and **◀** to move to the desired character and press the ENTER button to confirm. Please note the following **SPECIAL CHARACTERS** :

↵ confirm the modified value / * erase all / ← backspace

↔ move cursor back or forward

4 - Setting up the TM250

4.1 - The DVB settings menu

In this menu you can set the output frequency, bandwidth, output level and specific parameters for DVB-T.

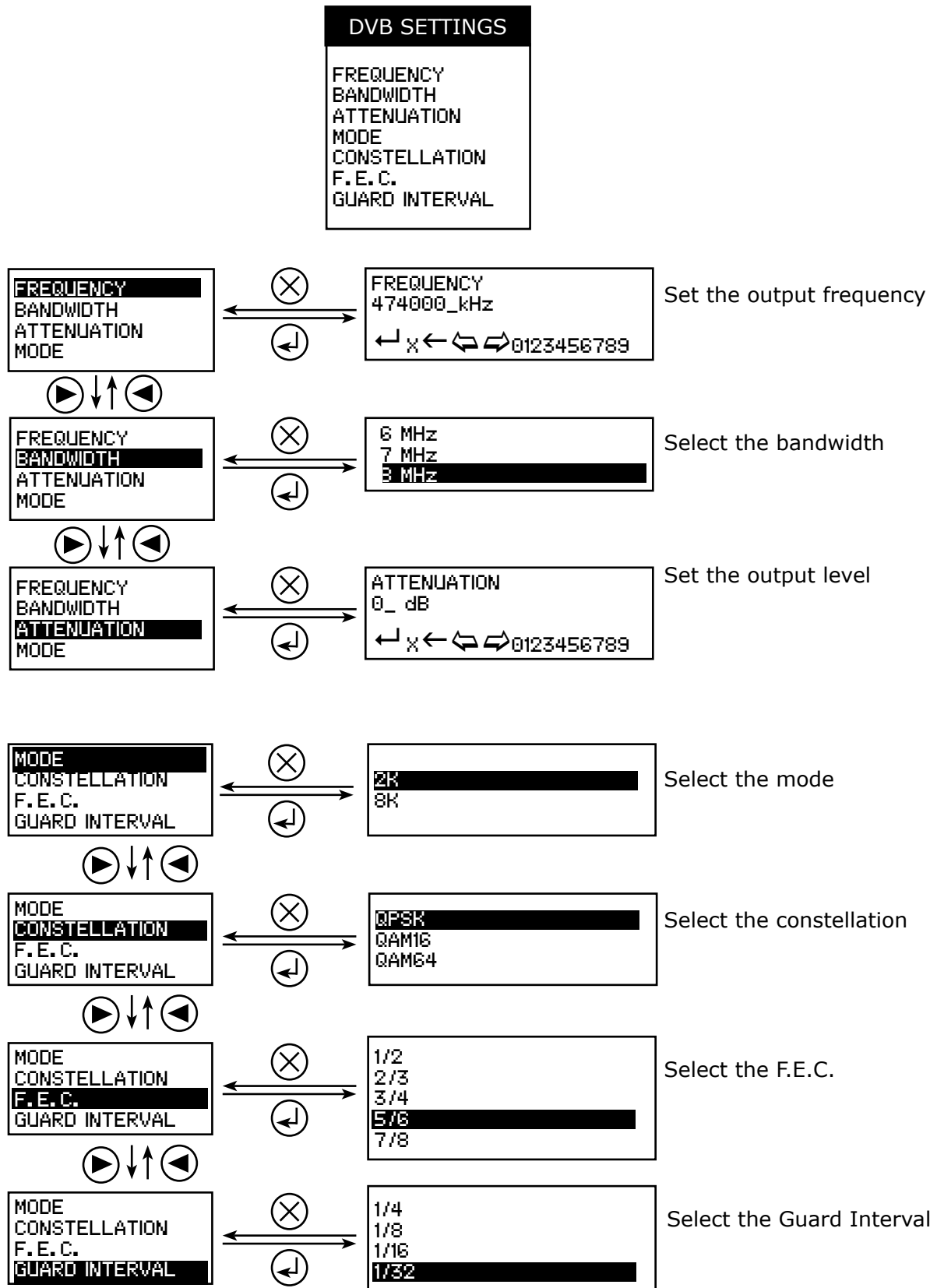

4.2 - The AV settings menu

In the A/V settings menu, you can set specific parameters for video and audio.

VIDEO SETTINGS
AUDIO SETTINGS

4.2.1 - Video settings

When you select VIDEO SETTINGS and press the ENTER button, the following submenu appears. It allows you to set the VIDEO parameters.

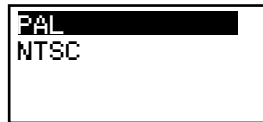
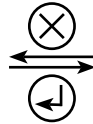
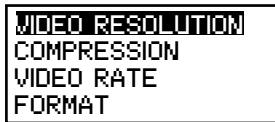

Select the video resolution

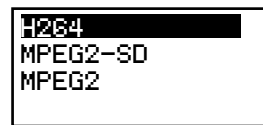
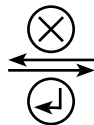
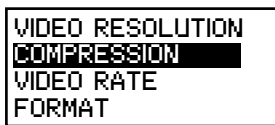

Select the compression type

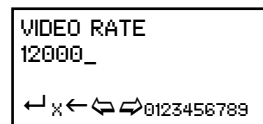
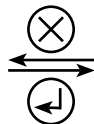
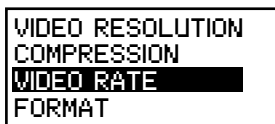

Set the video bit rate

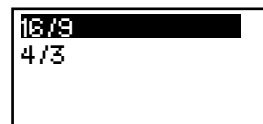
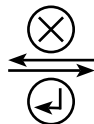
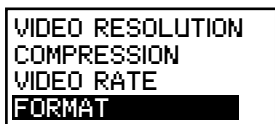

Select the format

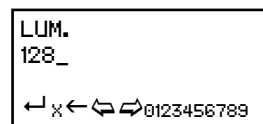
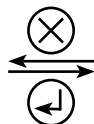

Set the luminosity

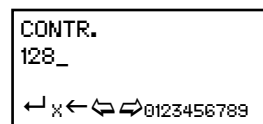
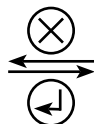
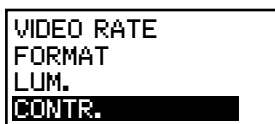

Set the contrast

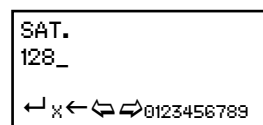
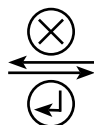
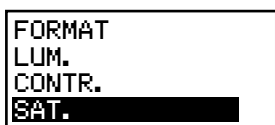

Set the saturation

4.2.2 - Audio settings

When you select AUDIO SETTINGS and press the ENTER button, the following submenu appears. It allows you to set the AUDIO parameters.

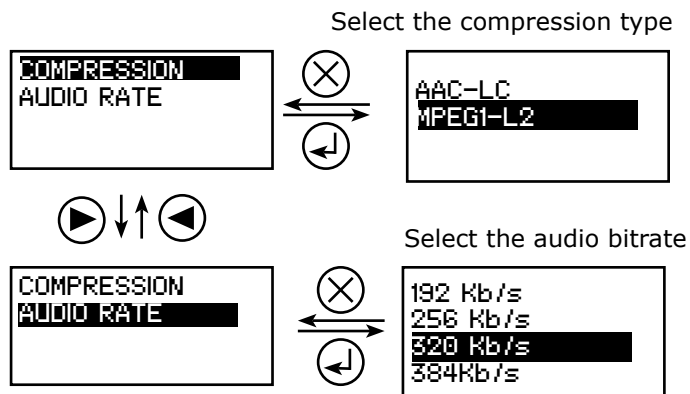

4.3 - The TS settings menu

This menu allows you to adjust specific parameters of the transport stream.

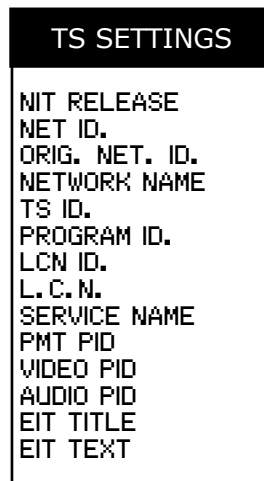

<p>NIT RELEASE NET ID. ORIG. NET. ID. NETWORK NAME</p> <p>⏪ ⏩ ⏴ ⏵</p>	<p>⊗</p> <p>↔</p> <p>⏴</p>	<p>NIT RELEASE 27_</p> <p>⏴ X ⏵ ⏪ ⏩ 0123456789</p>	<p>Set the NIT version</p>
<p>NIT RELEASE NET ID. ORIG. NET. ID. NETWORK NAME</p> <p>⏪ ⏩ ⏴ ⏵</p>	<p>⊗</p> <p>↔</p> <p>⏴</p>	<p>NET ID. 27_</p> <p>⏴ X ⏵ ⏪ ⏩ 0123456789</p>	<p>Set the Network ID.</p>
<p>NIT RELEASE NET ID. ORIG. NET. ID. NETWORK NAME</p> <p>⏪ ⏩ ⏴ ⏵</p>	<p>⊗</p> <p>↔</p> <p>⏴</p>	<p>ORIG. NET. ID. 27_</p> <p>⏴ X ⏵ ⏪ ⏩ 0123456789</p>	<p>Set the Original Network ID.</p>
<p>NIT RELEASE NET ID. ORIG. NET. ID. NETWORK NAME</p> <p>⏪ ⏩ ⏴ ⏵</p>	<p>⊗</p> <p>↔</p> <p>⏴</p>	<p>NETWORK NAME NoName_</p> <p>⏴ X ⏵ ⏪ ⏩ 0123456789</p>	<p>Set the NETWORK NAME</p>
<p>NET ID. ORIG. NET. ID. NETWORK NAME TS ID.</p> <p>⏪ ⏩ ⏴ ⏵</p>	<p>⊗</p> <p>↔</p> <p>⏴</p>	<p>TS ID. 100_</p> <p>⏴ X ⏵ ⏪ ⏩ 0123456789</p>	<p>Set the Transport Stream ID.</p>
<p>ORIG. NET. ID. NETWORK NAME TS ID. PROGRAM ID.</p> <p>⏪ ⏩ ⏴ ⏵</p>	<p>⊗</p> <p>↔</p> <p>⏴</p>	<p>PROGRAM ID 1_</p> <p>⏴ X ⏵ ⏪ ⏩ 0123456789</p>	<p>Set the PROGRAM ID.</p>
<p>NETWORK NAME TS ID. PROGRAM ID. LCN ID.</p> <p>⏪ ⏩ ⏴ ⏵</p>	<p>⊗</p> <p>↔</p> <p>⏴</p>	<p>EACEM ITC</p>	<p>Select the LCN ID.</p>
<p>TS ID. PROGRAM ID. LCN ID. L. C. N.</p> <p>⏪ ⏩ ⏴ ⏵</p>	<p>⊗</p> <p>↔</p> <p>⏴</p>	<p>L. C. N. 1_</p> <p>⏴ X ⏵ ⏪ ⏩ 0123456789</p>	<p>Set the LCN number.</p>
<p>PROGRAM ID. LCN ID. L. C. N. SERVICE NAME</p> <p>⏪ ⏩ ⏴ ⏵</p>	<p>⊗</p> <p>↔</p> <p>⏴</p>	<p>SERVICE NAME Chan A_</p> <p>⏴ X ⏵ ⏪ ⏩ 0123456789</p>	<p>Set the Program Name.</p>
<p>LCN ID. L. C. N. SERVICE NAME PMT PID</p> <p>⏪ ⏩ ⏴ ⏵</p>	<p>⊗</p> <p>↔</p> <p>⏴</p>	<p>VIDEO PMT 32_</p> <p>⏴ X ⏵ ⏪ ⏩ 0123456789</p>	<p>Set the VIDEO PMT</p>
<p>L. C. N. SERVICE NAME PMT PID VIDEO PID</p> <p>⏪ ⏩ ⏴ ⏵</p>	<p>⊗</p> <p>↔</p> <p>⏴</p>	<p>VIDEO PID 48_</p> <p>⏴ X ⏵ ⏪ ⏩ 0123456789</p>	<p>Set the VIDEO PID</p>
<p>SERVICE NAME PMT PID VIDEO PID AUDIO PID</p> <p>⏪ ⏩ ⏴ ⏵</p>	<p>⊗</p> <p>↔</p> <p>⏴</p>	<p>AUDIO PID 49_</p> <p>⏴ X ⏵ ⏪ ⏩ 0123456789</p>	<p>Set the AUDIO PID</p>

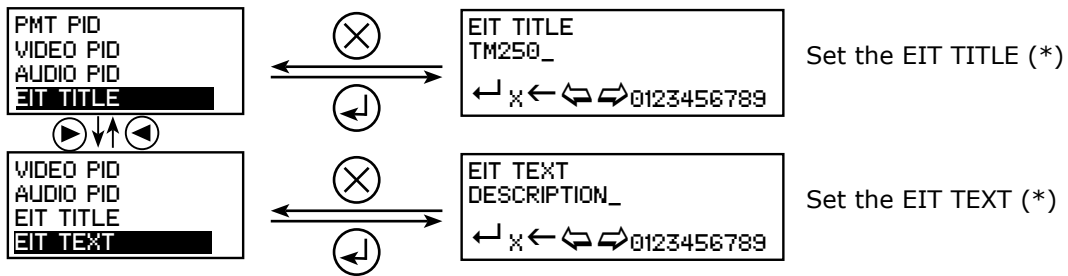

(*) EIT title and text will pop up on your television screen when pressing the INFO button on the handset of your TV, when watching the program coming from the TM250 modulator.

4.4- The language menu

Select in this menu your preferential language

4.5 - Default configuration

When selecting this option, all your modifications will be lost, and the default factory settings will be restored.

5 - Programming using a PC

The settings of the TM250 can also be changed using a PC.

First, please install the software **TMIFace** on your PC. You can download this software from our internet site **anttron.com**

After installation of this software, connect the TM250 using a USB cable (not included) to your personal computer. Then launch the program **TMIFace**.

On the display of the TM250 the message <USB> appears, indicating that the programming is now performed through your PC. The following window appears on your screen.

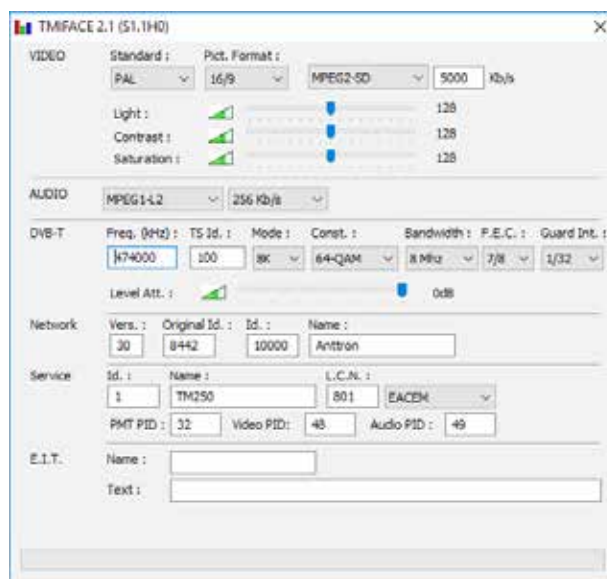

Now, all parameters discussed in Chapter 4 of this user manual can be modified by TMIFace.

6 - Technical specifications

Video input	Input	RCA
	Video Resolution	PAL-SECAM
	Compression	H.264 / MPEG2-SD / MPEG2 – bitrate 5-15 Mb/s
Audio input	Input	RCA
	Compression	AAC-LC / MPEG1-L2– bitrate 128-384 Kb/s
DVB Processing	Table insertion	PAT, PMT, SDT, NIT, EIT
	Configuration	Channel/network name, SID, LCN, TSID, ONID, NID, versions, audio, video PIDs...
DVB-T output	Output frequency / level	170-230 MHz + 470-862 MHz / > 80 dBμV
	Constellation - FEC	QPSK/16QAM/64QAM - 1/2, 2/3, 3/4, 5/6, 7/8
	Guard interval	1/4, 1/8, 1/16, 1/32
	Mode - MER	2K/8K - > 31 dB
Power	DC 2.1 mm connector	+5V
	Consumption	10 Watts
Dimensions	LxWxH	170x130x35mm
	Weight	0.6 kg
EAN code	TM250	5420037692507